

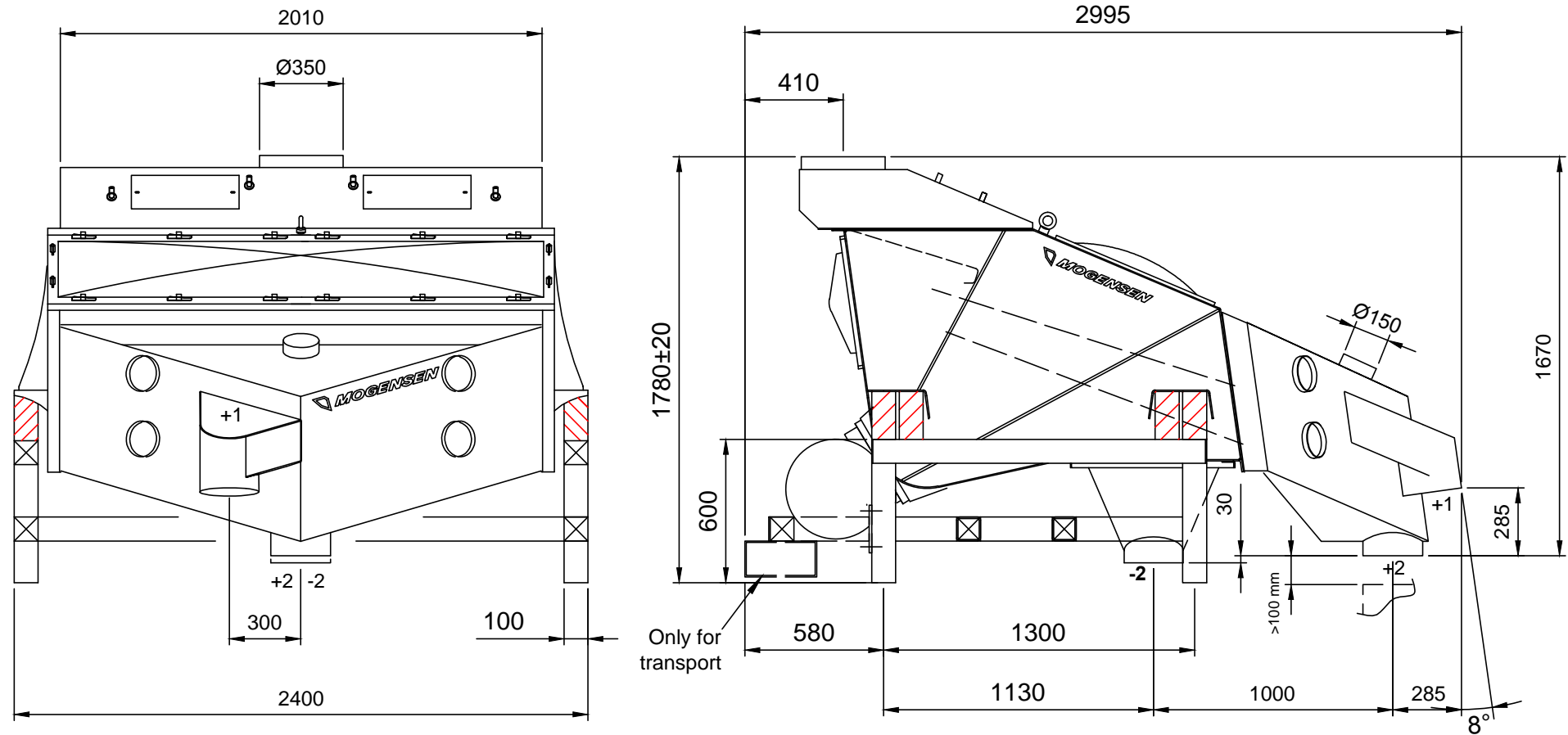

Dynamic load
 (4 pol 50Hz) + - 895 N at 24 Hz
 (6 pol 50Hz) + - 2050 N at 16 Hz

Weights:
 Sizer = ~1900 kgs
 Supportframe = 150 kgs

Screening surface: 2 x 2,6 m²



Outlets:
 Ø 250 mm

 FREDRIK MOGENSEN AB Hjo, SWEDEN	Ref.	Skala 1:25	Typ G202	
	Mogensen Sizer Type G202		Ritad 2004-03-04	Kontr. JJ
			Nr 49259	Rev. 0

Nr	Ant	Ändring och/eller medd.-nr	Datum	Inf	Godk
----	-----	----------------------------	-------	-----	------